

## THERMODYNAMIC INDEXES OF REAL DRIVING CONDITIONS OF GASOLINE AND LPG FUELLED ENGINE

Ireneusz Pielecha<sup>1</sup>, Wojciech Cieslik<sup>2</sup>, Wojciech Bueschke<sup>3</sup>, Maciej Skowron<sup>4</sup>

<sup>1,2,3,4</sup>Poznan University of Technology, Faculty of Machines and Transport, Poznan, Poland

<sup>1</sup>e-mail: ireneusz.pielecha@put.poznan.pl

<sup>2</sup>e-mail: wojciech.cieslik@put.poznan.pl

<sup>3</sup>e-mail: wojciech.bueschke@put.poznan.pl

<sup>4</sup>e-mail: maciej.skowron@put.poznan.pl

---

**Abstract:** *The aim of the conducted tests was to assess the method of delivering additional fuel dose in transient conditions and to determine the impact of this additional fuel dose on the engine operation conditions. The experimental tests were conducted in typical urban driving conditions. In the study was used system for indicating and acquisition of fast-varying data; the combustion pressure in the first cylinder of the 3-cylinder engine with spark ignition was measured, as well as the voltage on the petrol injectors and the liquefied petroleum gas injector. The post-processing analysis enabled defining engine operation indexes taking into account the aforementioned parameters. Also indicated mean effective pressure, the heat release rate and the amount of the heat released were analysed. In addition, the indexes of transient conditions of engine operation per one cycle were specified: change of the engine speed, of the maximum combustion pressure, of the indicated mean effective pressure and change of the heat release rate.*

**Key words:** *liquefied petroleum gas, combustion engine, thermodynamic indexes.*

---

### 1. Introduction

Propane-butane gas fuelled systems (LPG – liquefied petroleum gas) have become in recent years quite common both in Poland and in Europe. Low price of LPG reduces the operating cost of a passenger car, which enables the user more the car intensive exploitation. Additionally, gaseous fuels, due to low carbon content in a molecule, have significantly lower emission of CO<sub>2</sub>, making them environmentally friendlier. Gaseous fuels, due to their physicochemical properties are more demanding with regard to: the technical engine condition, the correct ignition operation and supply systems and tightness of the intake and exhaust systems. Fuel costs reduction by 50 to 60% in comparison with the cost of petrol or diesel fuel (Autogas in Europe, 2014) provides economical base for development of the market of LPG gas systems and the whole infrastructure related to the operation of a LPG-fuelled cars. The current demand in consumer market for dual-powered vehicles with particular emphasis on the LPG-fuelled cars, forced the top manufacturers of passenger vehicles to introduce into their offer the drive units factory-fitted with LPG systems (Cieslik et al., 2014).

Beside the research on different configurations of petrol injection (Merkisz-Guranowska and Pielecha, 2014; Pielecha and Borowski, 2014), and concepts of installing both the petrol and diesel injectors (Pielecha et al, 2013; Merkisz et al., 2014; Pielecha et al., 2014) also the tests of gaseous fuels such as LPG or CNG are important. The results of optical tests on gaseous fuels (Wislocki et al, 2010a; Wislocki et al, 2010b) have vindicated their use. Tests on LPG fuel (injection of liquid or gaseous form (Mizushima et al, 2009)) suggest the possibility of its use both in spark-ignition engines with indirect (Lawankar, 2013) or direct injection (Park et al., 2013a; Park et al, 2013b) and in diesel engines (Fontaras et al., 2012) indicating good properties of its dispersion (Lee et al., 2013). The choice of fuel ensues first and foremost from the economic calculation and from the requirements of the engines, in which it is to be applied. Decreasing world's liquid fuel sources and the need to reduce emissions into the atmosphere of exhaust emission, contribute to the search for alternative sources of power for combustion engines.

As it was mentioned, LPG consists mainly of propane and butane. The proportions of the two

components are different, depending on the legal conditions in force in particular states and on the place of distribution – they can differ during winter and summer (e.g. in France from 01.11 to 31.03). LPG is sold with the proportions of propane to butane ranging from 100%/0% - 60%/40%, while in the remaining period the proportion is 40%/60% to 30%/70%) (European LPG, 2016). Pure LPG is colourless and scentless. It is a flammable liquid and for safety reasons it is enriched with odorant. Properties of LPG in comparison to petrol and natural gas are presented in Table 1.

A significant advantage of LPG over petrol is its high octane number and high lower heating value. Considering the chemical composition of LPG according to Elnajjar et al. (2013), increasing the butane share in the mixture causes a slight increase in the overall engine efficiency, which is the bigger, the smaller the geometric compression ratio of the engine is while reducing the rate of pressure increase in the cylinder in comparison to the mixture rich in propane.

LPG is stored in tanks as liquefied gas. The systems with injection of LPG in liquid phase are not widely used. In the tests conducted by Bayraktar and Durgun (2004) the spark-ignition engines supplied with petrol and LPG in varying proportions injected in the gaseous phase were subjected to experimental analysis. There was observed a significant increase in the combustion rate. For high engine speed and fixed ignition angle of advance, almost 100% of the fraction of burned fuel was achieved in time shorter by approx. 23%. The increased combustion rate is also associated with an increased engine load, which is reflected in an increase in the maximum pressure in the cylinder and high values of combustion temperature.

LPG expansion and transition into gaseous phase is associated with a significant increase in the volume and displacement of a certain volume of air in the system supplying charge to the engines with indirect injection, and therefore with a decreased fill ratio of the cylinder. Based on the results of the studies cited, it can be concluded that the decrease in the fill ratio is the larger, the higher the dose of gaseous fuel is. The analysis of the literature shows that despite the increase in thermal efficiency, the torque generated by the motor is smaller (mainly because of the reduction of the fill ratio of the cylinder). This decrease may be compensated through a change of

the ignition angle of advance, which, however, means an additional thermal load on the engine (Bayraktar and Durgun, 2004).

In the light of the presented advantages of LPG as an engine fuel and the reduction of CO<sub>2</sub> emissions compared to petrol (approx. 3.03 kg compared to approx. 3.21 kg of CO<sub>2</sub> from combustion 1 kg of fuel) an important issue is the thermodynamic analysis of the operation of LPG-fuelled unit, especially in real working conditions.

## 2. Methodology of tests conducted in real traffic conditions

The test were carried out in real traffic conditions with the use of the measuring apparatus which enabled recording a variety of fast-varying values at the time of test run duration. To measure the pressure in the cylinder of the engine, a sensor mounted on the spark plug was used (measurements were carried out with the use of a piezoelectric sensor mounted in the spark plug with the measuring range of 0 to 25 MPa and a sensitivity of 15.83 pC/bar, designated GH13Z3 by AVL). With the use of current clamps, the signals of opening start for both, the petrol injector and the gas injector were measured. With the use of the voltage probe were also conducted voltage measurements on high-voltage cables in the secondary circuit of the ignition system and the measurements of engine speed signal from the Hall sensor. Fast-varying signals were recorded with the use of a mobile system – IndiSmart 621 by AVL.

Technical characteristics of the vehicle subjected to the tests in transient conditions for petrol- or LPG-fuelled engines are presented in Table 2.

The tests in real traffic conditions were conducted in urban area. Two test runs were conducted along the same route ( $s = 8,700$  m) in the city centre: the first with the use of engine fuelled with petrol, second – with the use of LPG. The duration of the first test run was 1322 s, and of the other 1902 s; the average speeds were, respectively, 23.55 kph and 16.76 kph. The obtained differences arise from the change in the volume of traffic at the time of the test (Table 3). To conduct the tests in transient conditions, the vehicle was prepared in the following way: in the road tests were analysed fast-varying parameters of the engine operation; its thermodynamic indexes were determined in relation to particular cycles of engine operation (Fig. 1).

Table 1. The comparison of LPG, petrol and CNG properties

Parameter	Unit	Petrol	LPG	CNG
State of matter		liquid	liquid	gaseous
Octane number		95-98	90-120	120+
Methane number			60-80	63-88
Sulphur content	ppm	<10	<50	<100
Vapour pressure/at temperature		45±90 kPa/37.8°C	< 1550 kPa/40°C	
Flammable concentration in air	%	1.3-7	2-9	5-15
Stoichiometric air-fuel ratio	-	14.7	15.6	17.4
Lower heating value	MJ/kg	43.45	46.61	47.14
Density at 1 bar	kg/m <sup>3</sup>	745	508	0.777

Source: Boundy et al. (2011), Andersen (1999).

Table 2. Technical characteristics of the engine

Displacement	1198 cm <sup>3</sup>
Bore × stroke	76.5 mm × 86.9 mm
Compression ratio	10.5:1
Power @ rpm	55 kW @ 5400 rpm
Torque @ rpm	112 N·m @ 3750 rpm
Break mean effective pressure	1.02 MPa
LPG installation	Landi Renzo – Direct OMEGAS

Table 3. Conditions of test runs for petrol- or LPG-fuelled vehicles

Fuel	Petrol	LPG
Distance	8 700 m	8 700 m
Time	1322 s	1902 s
Max speed	71 kph	69 kph
Average speed	23.55 kph	16.76 kph
No. of engine cycles	17 378	21 388

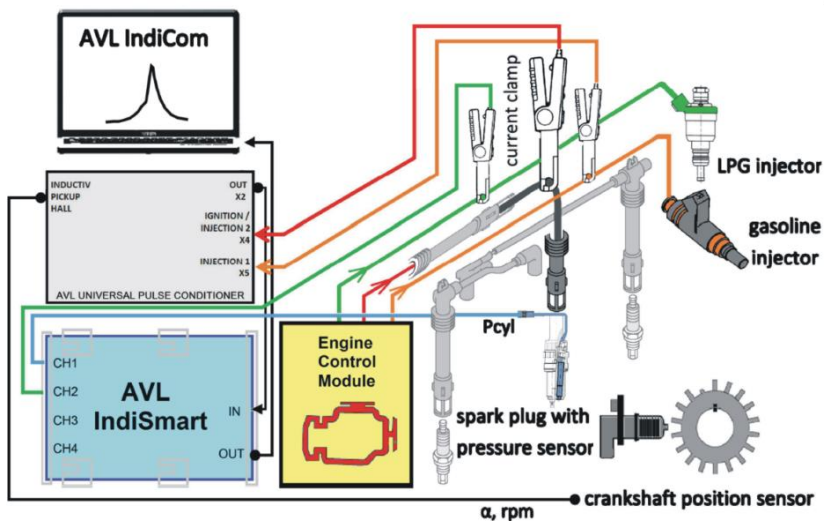

Fig. 1. Diagram of the system for measuring fast-varying signals

For this purpose the signal from the inductive sensor of the crankshaft rotational speed was transmitted in parallel to the ECM (electronic control unit) and to the AVL conditioner. The angular resolution of signal equalled  $\Delta\alpha = 1^\circ\text{CA}$ . The voltage signal from the ignition coil was measured on the cable using the voltage clamp meter, and the signal from the LPG and petrol injectors is measured with the current clamps. The first of the three signals mentioned was delivered to the universal pulse conditioner, which was afterwards passed to the system for measuring fast-varying signals – AVL IndiSmart, and one of the petrol injector voltage signals was connected directly to the IndiSmart conditioner. The signal from the spark plug adapter (in-cylinder pressure) equipped with pressure sensor was connected to the acquisition system. Recording and further results analysis was possible through connecting AVL IndiSmart and PC equipped with recording software AVL IndiCom. Analysis of the research results was carried out with the use of AVL Concerto V4.5 program. This program allowed processing the recorded pressure waveforms and diagnostic data. As a result the calculations and graphs of selected mathematical, statistical and thermodynamic values were obtained.

### 3. Analysis of the representativeness of test runs and engine operation conditions

An analysis of the representativeness was based on a comparison of the value of the mean indicated pressure  $p_i$  in the general characteristics of the engine.

The values of  $p_i$  were calculated on the basis of the following equation:

$$p_i = \frac{1}{V} \int_{-360}^{360} P dV \quad (1)$$

where:  $V$  – displacement and  $P$  – cylinder pressure. Operating conditions for a combustion engine fuelled with petrol and diesel oil were similar throughout the whole test. It is evidenced by the values of indicated mean effective pressure  $p_i$  (IMEP) obtained during measurements (Fig. 2). This means that it is possible to compare the two test runs, as the obtained external characteristics don't differ from each other.

Powering an engine with LPG required increasing the range of engine speed. Increase of this range occurs mainly at speeds ranging from 3600-3900 rpm. Within this range, the petrol-fuelled engine in the test conditions wasn't operating despite the same test route.

The analysis of the similarities is also presented in the form of time-density map (Fig. 3). As it can be seen, there are no significant differences in the characteristics of the engine operation for the test runs along the same route for different ways the engine fuelling. Similar (average) ranges of engine speed and load are utilized. A significant share of engine operating time (for petrol and LPG supply) falls within the range of speeds 1775-2775 rpm for varying load. This means that the achieved characteristics are representative and that can be compared with each other. Significant similarity in the share of engine operation time is observed also during engine operation without load, which further points to the analogy of the routes and conditions of test runs.

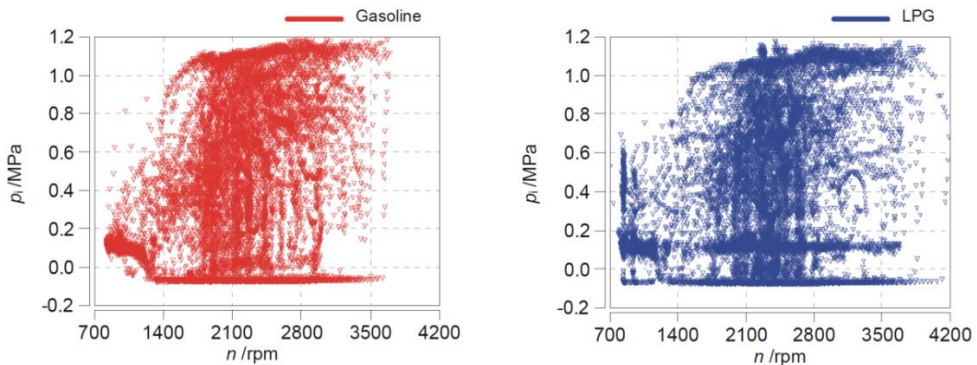

Fig. 2. Operating conditions of the combustion engine during the two test runs on the same route in urban conditions for the real traffic volume

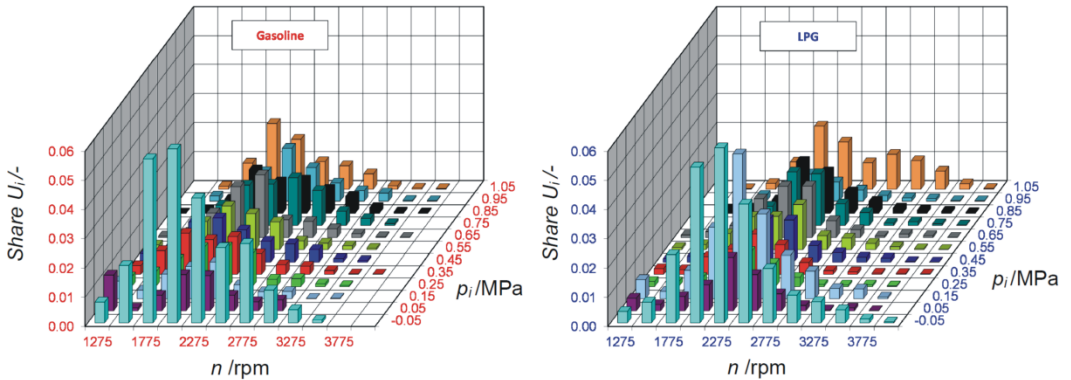

Fig. 3. Shares of the engine operation time on the  $p_i$ -speed characteristics during road tests of the engine fuelled with petrol and LPG

**4. Analysis of engine operation cycles in transient conditions**

Analysis of the engine operation required selection of similar conditions during test runs. For this reason similar conditions, from vehicle acceleration to its stop, were analysed. Successive 300 cycles of engine operation are presented (Fig. 4) taking into account changing gears while driving. The figure suggests that until the third change of gears the engine operating conditions should be considered similar (up to about 130<sup>th</sup> engine operating cycle). The acceleration conditions of the engine were analysed on the basis of selected ten successive cycles of engine operation (cycles from 30<sup>th</sup> to 40<sup>th</sup> are presented in Fig. 5). The analysis of the individual engine operation cycles during acceleration indicates greater similarity of operation

cycles in case of petrol-fuelled engine. The difference in speed for both compared cycles amounts to 82 rpm, which is a variation of 3.5%. Greater uniformity of operation of petrol-fuelled engine is indicated by the shape of characteristics of pressure in the cylinder and the angle of maximum combustion pressure occurrence.

The maximum values of pressure  $P_{max}$  occur at approximately the same crankshaft angle rotation (Fig. 6). However, in case of engine fuelled with LPG was observed a significant dispersion of maximum values of combustion pressure  $P_{max}$  and the angle of its occurrences. This results in certain engine operation instability, which might be caused by not very precise (non-repeatable) dosing of gaseous fuel.

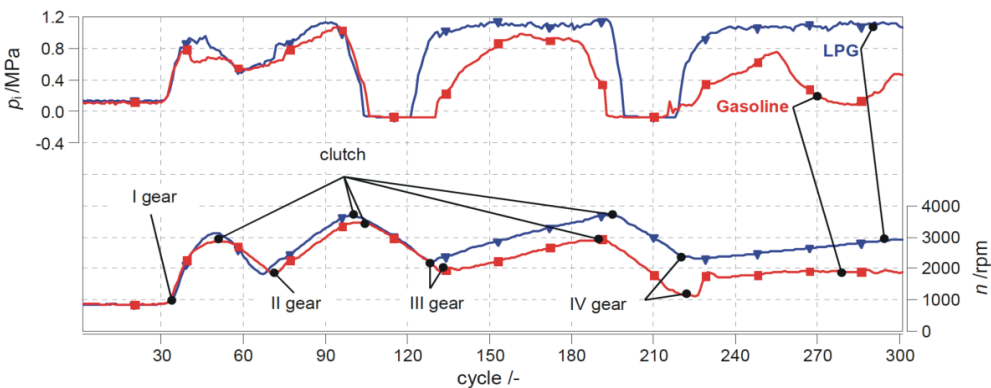

Fig. 4. The indicated mean pressure during acceleration phase vs. engine speed at the change of gears during driving

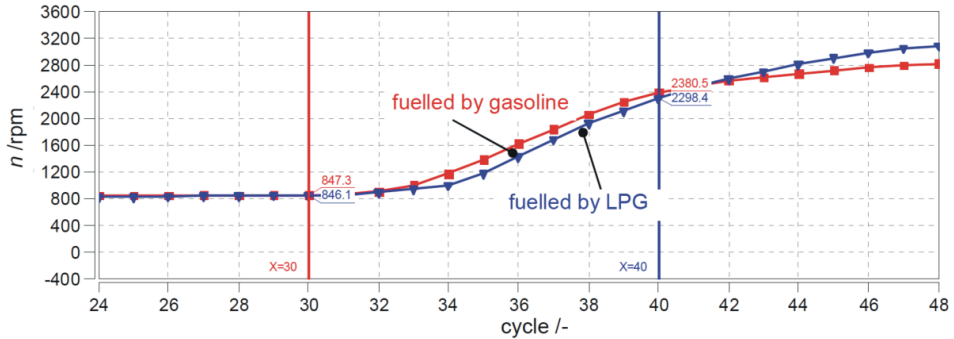

Fig. 5. The change of engine speed during acceleration phase in successive recorded cycles

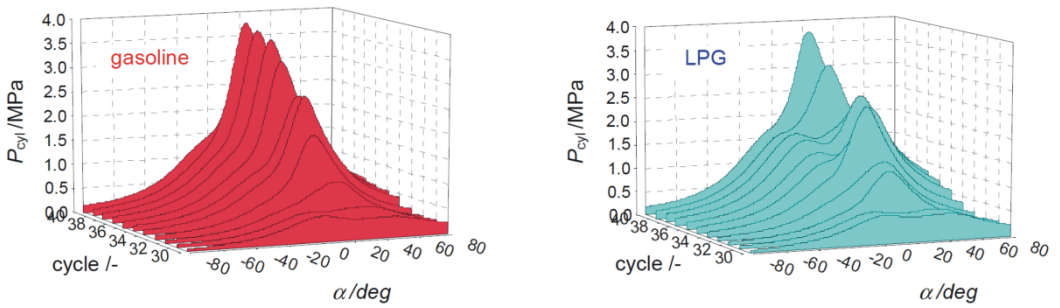

Fig. 6. Characteristics of pressure in the cylinder during acceleration of the petrol-fuelled engine (left) and LPG-fuelled engine (right) vs. changes of the vehicle speed in the successive ten cycles

Considering the change in speed of engine operating in transient conditions, the change of combustion pressure vs. crank angle was compared for first four cycles of acceleration. Pressure values are shown in Figure 7. Characteristics of pressure changes in the cylinder in the first and fourth cycle of the engine operation are very similar. There are, however, significant differences between intermediate cycles. The obtained increases are much more beneficial in case of operation of the petrol-fuelled engine (smaller changes indicate lower mechanical load of the engine) compared to engines supplied with gaseous fuel. Slightly lower value of the maximum pressure of LPG combustion may result from a lower engine load, i.e. from supplying smaller amounts of the mixture. The obtained lower values of speed for engine fuelled with LPG in the 4<sup>th</sup> acceleration cycle (corresponding to 34<sup>th</sup> cycle in Figure 4) confirm the above statement.

Using the results of the indicatory studies the rate of heat release –  $dQ/d\alpha$  and accumulated heat  $Q$  were determined as:

$$\frac{dQ}{d\alpha} = \frac{\kappa}{\kappa-1} \left( \frac{P_{\alpha} + P_{\alpha+1}}{2} \right) (V_{\alpha+1} - V_{\alpha}) + \frac{1}{\kappa-1} \left( \frac{V_{\alpha} + V_{\alpha+1}}{2} \right) (P_{\alpha+1} - P_{\alpha}) \quad (2)$$

$$Q = \int \frac{dQ}{d\alpha} d\alpha \quad (3)$$

where the indexes  $\alpha$  and  $\alpha+1$  are a current and a subsequent value of pressure  $P$  in the cylinder or its corresponding cylinder volume  $V$ . These calculations were conducted for closed operating space of the cylinder, that is within the range from closing the inlet valve to opening the outlet valve. Analysis of the heat release is presented in Figure 8 in the form of two charts based on acceleration of engine shown in Fig. 7. Analogous to changes of pressure in cylinder during combustion, also the characteristics of heat release during combustion for both fuels are very similar in the first cycle.

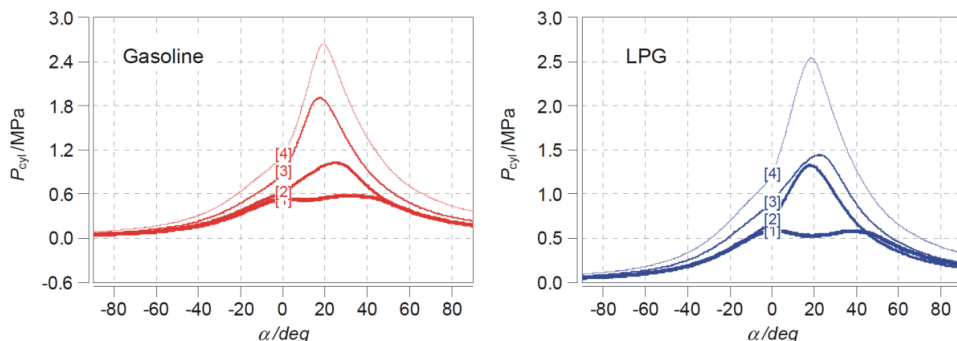

Fig. 7. Comparison of the first four cycles of engine operation (in-cylinder pressure) during acceleration

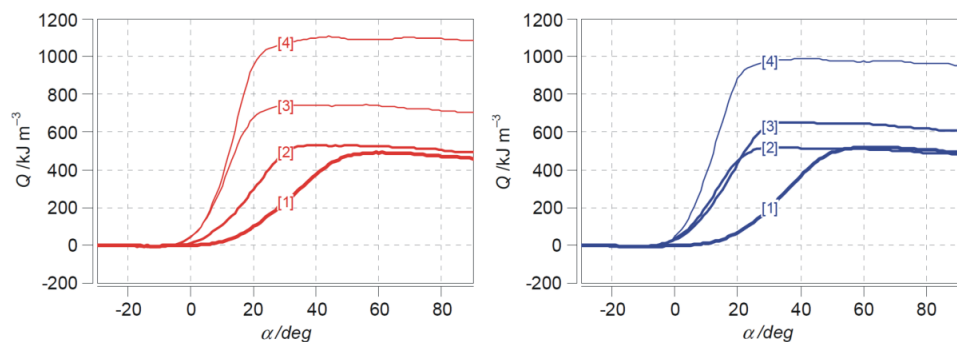

Fig. 8. Comparison of the first four cycles of engine operation (heat release in cylinder) during acceleration

However, a slight difference in values of heat release is noticeable for the fourth cycle for both fuels. The lower value of heat release during combustion of LPG ensues from lower values of pressure achieved during combustion. These changes arise from the lower heating value of the gaseous fuel and inaccurate adjustment of the change in the way of fuel supply. The rate of change of the gaseous fuel injection time is too small to obtain similar values of the pressure increase rate after ignition.

##### 5. Estimation of the instantaneous operational indexes of the combustion engine

The analysis of the instantaneous indexes of engine operation was carried out for the rate of the changes of given parameters (depending on the crank angle): the indicated pressure  $dp_i$ , pressure in cylinder  $dP_{cyl-max}$ , rate of pressure increase after ignition  $d(dP_{cyl})$  and engine speed  $d\dot{n}$ . Also the angle of 50% of mass burnt fuel (so called combustion centre)  $CoC$  and the duration of combustion  $t_{comb}$  were estimated.

Analysis of the engine operation changes was made on the basis of the  $p_i$  change rate during changes of combustion engine speed. For this reason functions  $d\dot{n} = f(dp_i)$  were compiled – Fig. 9. For petrol-fuelled engine were found lower values of engine speed changes. At the same time, during the analysis of  $p_i$  values, no significant changes were observed. This means that both fuels enable stable engine operation, without any distinct signs of rapid changes in combustion, which could result in a reduction of the durability of the drive unit.

For both test runs the average increases of mean indicated pressure per one cycle were compared as a function of engine speed change per one cycle. Figure 9 presents a comparison of these indexes for test runs of engines fuelled with petrol and LPG. Higher value of changes of  $dp_i$  for lower value of changes of engine speed  $d\dot{n}$  means significant engine load, as e.g. for acceleration to a higher gear or driving up the elevation. Similarly, smaller changes of the mean indicated pressure for larger changes in engine speed mean less engine load caused, for



example, by acceleration at a lower gear or by higher engine speed. During both test runs a significant density of points for the zero value was observed (stationary engine operating conditions). During fuelling engine with LPG a much more significant dispersion of the indicated pressure is observed. Maximum values of increments of  $dp_i$  and engine speed  $dn$  amount, respectively, to 0.247 bar/cycle and 254.1 rpm/cycle during supplying with LPG and to 0.155 bar/cycle and 233.9 rpm/cycle for supplying with petrol. Both values are higher during supplying the engine with gaseous LPG fuel.

The analysis of the changes in the maximum pressure  $dP_{\text{cyl-max}}$  per one cycle is presented in Fig.10. The distribution of points in relation to the  $dn$  axis is the same as in Fig.9. An increased density of the measuring points in the vicinity of zero value for both fuels can be noticed. The largest values of the pressure variation were observed during

combustion of LPG fuel, amounting to 1.32 MPa/cycle compared to 0.8 MPa/cycle during the combustion of petrol. The changes of the maximum pressure per one cycle are smaller for fuelling engine with petrol, which could mean more uniform operation of the engine and smaller changes in its operation resulting from fuel dosing.

Also the maximum rate of pressure variation in a cylinder between engine operation cycles was analysed. The results are presented in Fig. 11 as a function of engine speed change per one cycle. During combustion of the gaseous fuel, a much more significant dispersion of the values is observed. The maximum values for LPG fuel supply amount to 0.71 MPa/deg/cycle. During combustion of petrol, smaller increments of pressure, not exceeding 0.6 MPa/deg/cycle, were noticed. Most of the measurement points fall within the range of values from  $-0.3$  to  $0.3$  MPa/deg/cycle.

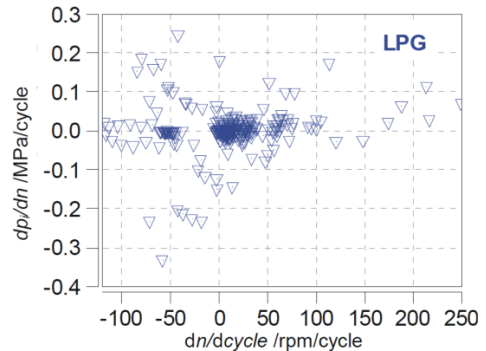
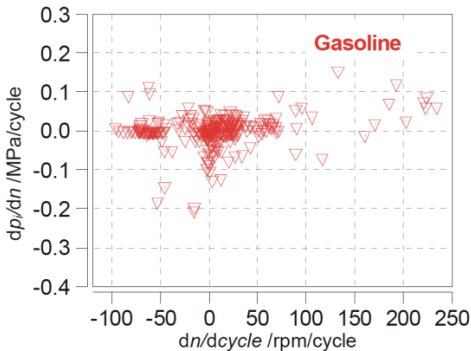

Fig. 9. Characteristics of IMEP change rate and engine speed in successive cycles of operation of engine fuelled with petrol and LPG

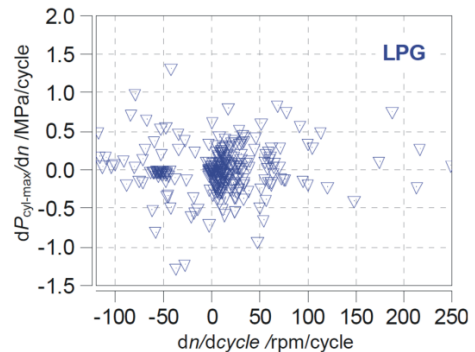
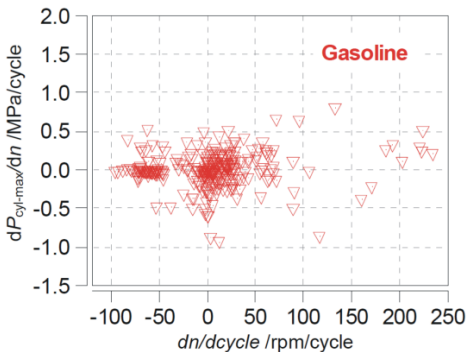

Fig. 10. Characteristics of maximum cylinder pressure change rate and engine speed in successive cycles of engine operation with petrol and LPG supply fuel supply



For both test runs the engine used the same ignition map. It can be assumed that the beginning of combustion of both fuels under the same conditions took place during the same phase of the crankshaft rotation. Both fuels are burnt, however, in a different way. Figure 12 shows the dependence of the angle of the centre of combustion ( $MBF50$ ) and the end of the combustion ( $MBF90$ ) as a function of the start of combustion ( $SOC$ ). What is noticeable, is the occurrence of combustion start about  $2^\circ$  of crankshaft rotation earlier during for LPG than for combustion of petrol. LPG combustion causes earlier occurrence of both  $MBF50$  and  $MBF90$ . For the same angle of the start of combustion of both fuels, the angle of occurrence of those values is even  $10^\circ$  higher for combustion of petrol. However, it is not possible to conclude on the extent to which the points are comparable. The maximum difference in occurrence of the angle for  $MBF50$  is approx.  $10^\circ$ , and for  $MBF90$  it is approx.  $20^\circ$ . It means that the gaseous fuel begins to burn about  $2^\circ$  earlier and finishes burning about  $20^\circ$  earlier – which means shorter time of combustion. However, there is no certainty as to the degree in which acceleration of the combustion start contributed to shortening the combustion time. What can be observed is the tendency to increase the angle of occurrence of  $MBF50$  and  $MBF90$  along with the delay of  $SOC$  regardless of the fuel used.

Also the time of combustion as a function of the angle of occurrence of the centre of combustion for  $MBF50$  was analysed. The results are shown in Figure 13. During combustion of both fuels was

observed similar tendency for delayed occurrence of  $MBF50$  along with the increase of the combustion time. Noticeable is the reduced dispersion of the values of combustion of gaseous fuel at a constant value of the centre of combustion. In most cases, the time of LPG fuel combustion does not exceed 38 degrees of crankshaft rotation, while combustion of petrol reaches 50 degrees. The dispersion of occurrence of  $MBF50$  during combustion of petrol is 45 degrees and during combustion of LPG – 25 degrees. What should be noted is the increased time of petrol combustion compared to the time of LPG combustion for equal values of the centre of combustion.

The heat release rate during the combustion of both fuels is shown in Fig. 14. The analysis was carried out in the function of the mean indicated pressure. During combustion of both fuels the tendency for increasing the maximum heat release rate  $dQ_{max}$  with the increase of  $p_i$  can be noticed. During combustion of gaseous LPG fuel, however, a higher density of points for large values of  $p_i$  within the range of 1.0-1.2 MPa and  $dQ_{max}$  in the range of 6 to 15 kJ/m<sup>3</sup>deg/cycle might be observed. This is confirmed by the results presented above, and means that burning of gaseous fuel proceeds much faster and with greater intensity.

The analysis of the amount of heat release (Fig. 15) during petrol combustion indicates a smaller value of the maximum heat realise with the offset of characteristics towards accelerated start of combustion compared to the characteristics of LPG combustion.

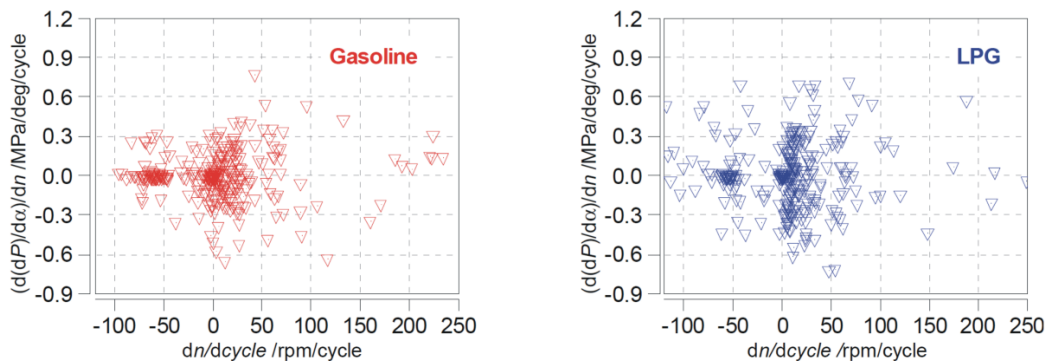

Fig.11. Characteristics of  $dP_{cyl}/d\alpha$  change rate and engine speed in successive cycles of operation of engine fuelled with petrol and LPG

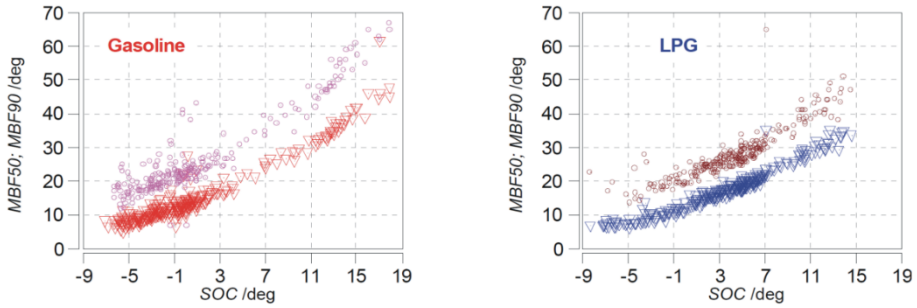

Fig. 12. Characteristics of CoC and SOC of operation of engine fuelled with petrol and LPG

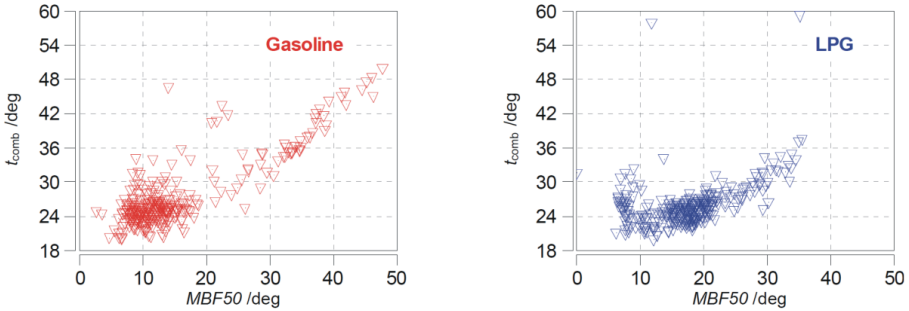

Fig. 13. Characteristics of  $t_{comb}$  and  $MBF50$  of engine operation with petrol and LPG supply fuel supply

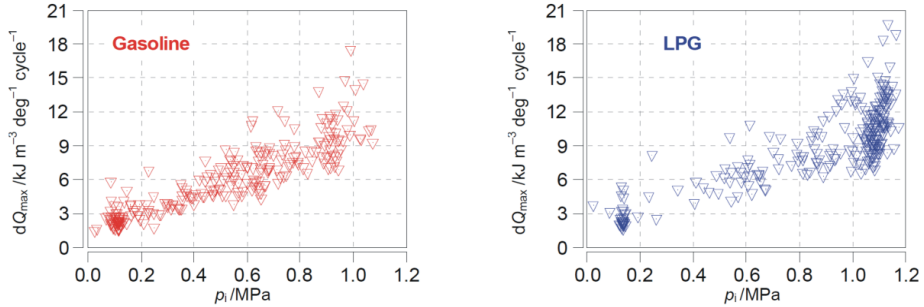

Fig. 14. Characteristics of  $dQ_{max}$  and  $p_i$  of engine operation with petrol and LPG supply

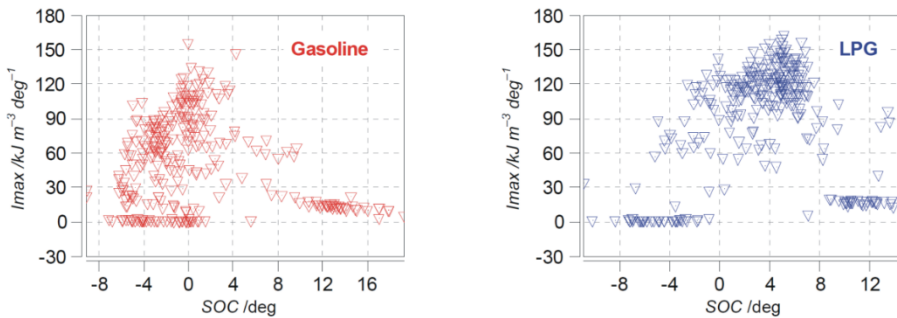

Fig. 15. Characteristics of  $I_{max}$  versus SOC of engine operation with petrol and LPG supply

### 6. General characteristics of the operation in transient conditions

The general characteristics of the pressure rise rate increase after ignition during acceleration is shown in Figure 16. The drawing shows that combustion of petrol results in larger values of  $dP_{cyl-max}/d\alpha$ , especially within the range of heavy engine loads. The isolines of pressure increase rate during LPG combustion are more regular and the increase of the load does not change these dependencies.

During the combustion of petrol the areas of the increased combustion rate appear, which is caused by the increase of the fuel dose at a given load. Increased combustion rates can indicate the possibility of obtaining greater acceleration of the vehicle with a petrol-fuelled engine compared to LPG-fuelled engine. In Figure 17 are presented general characteristics of the maximum pressure in the cylinder. Comparing both characteristics in the range of small loads (below 100 kPa) it can be concluded that the petrol-fuelled engine achieves

higher values of  $P_{cyl-max}/d\alpha$  already at about 2500 rpm, unlike LPG-fuelled engines, which achieve higher values after exceeding 2800 rpm. For heavy engine loads a difference in the maximum values can be seen. The area over 5 MPa is significantly higher for the petrol-fuelled engine compared to engine fuelled with LPG.

The general characteristics of the centre of combustion ( $CoC$ ) are presented in Figure 18. For the range of small loads, the  $CoC$  value is achieved faster for LPG combustion, which indicates higher combustion rate. The trend is reversed for high loads, which is particularly evident for  $p_i$  of approximately 700 kPa.

The characteristics of the end of combustion are presented in Figure 19. The area of the end of combustion at about 25 deg after TDC during combustion of petrol is much larger than the area during combustion of LPG. It can be concluded that the maximum doses of LPG fuel burn longer at low engine speeds.

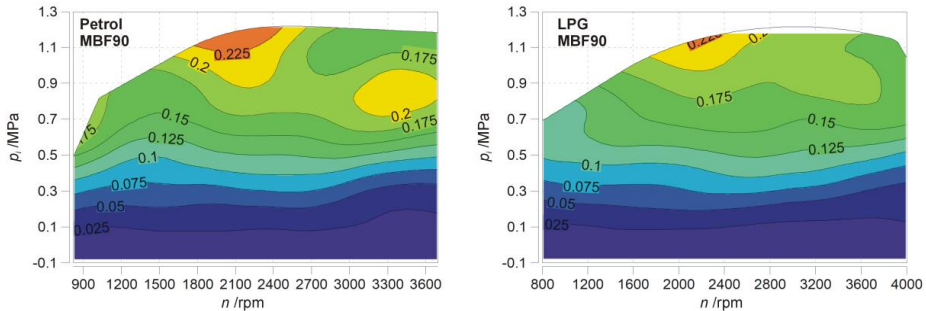

Fig. 16. Interpolated operating areas of engine fuelled with petrol and LPG during the acceleration phase, with indication of the maximum cylinder pressure rise rate (data on the basis of 300 cycles shown in Figure 3)

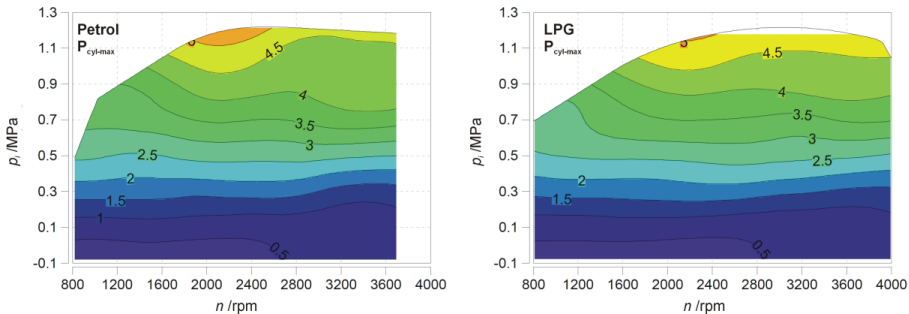

Fig. 17. Interpolated operating areas of engine fuelled with petrol and LPG during the acceleration phase, with indication of the maximum values of combustion pressure in the cylinder (based on all recorded cycles during a test run)

All the presented general characteristics were carried out on the basis of the same test route. Characteristics of petrol-supplied engines indicate that the vehicles cover the route with lower maximum speeds compared to characteristics of LPG-fuelled engines. This points to the need for increased engine power/displacement ratio, which is caused by a lower combustion efficiency resulting from the lack of a dedicated LPG fuel injection system in the test engine. That means that the follow-up studies on the comparison of the thermodynamic conditions of the combustion process can be carried out also taking into account the dedicated injection systems of liquid fuel (petrol) and gas (LPG). A further stage of the study should also take into account the road tests using systems measuring emissions of exhaust fumes.

## 7. Conclusions

The conducted tests enabled comparison of the performance of engine fuelled with petrol and LPG in real operating conditions during operation of the vehicle.

Comparative analysis of engine operation cycles in transient conditions (acceleration) indicates that:

- 1) Characteristics of pressure changes in the cylinder in the first and fourth cycle of the engine operation are very similar. There are, however, significant differences between intermediate cycles.
- 2) The lower value of heat release during combustion of LPG ensues from lower values of pressure achieved during combustion. These changes arise from the lower heating value of the gaseous fuel and inaccurate adjustment of the change in the way of fuel supply. The rate of

change of the gaseous fuel injection time is too low to obtain similar values of the rate of pressure increase after ignition.

On the basis of the comparative analysis of the instantaneous operational indexes of the combustion engine it was concluded that:

- 1) During fuelling engine with LPG, a much more significant dispersion of the indicated pressure is observed. Maximum values of increments of  $dp_i$  and engine speed  $dn$  are, respectively: 0.247 bar/cycle and 254.1 rpm/cycle during supplying with LPG and 0.155 bar/cycle and 233.9 rpm/cycle for supplying with petrol. Both values are higher during supplying the engine with gaseous LPG fuel.
- 2) The changes of the maximum pressure per one cycle are smaller during fuelling engine with petrol, which could mean more uniform operation of the engine and smaller changes in its operation resulting from fuel dosing.
- 3) Much higher maximum rates of pressure variation in a cylinder between engine operation cycles during combustion of gaseous fuel compared to combustion of petrol were observed.
- 4) For the same time of combustion  $t_{comb}$ , the centre of combustion (CoC) occurs earlier during combustion of petrol, which indicates a faster initial progress of the process for liquid fuel. For LPG there is a tendency for longer duration of the first half of the combustion process. However, as the total combustion time is comparable with the combustion of petrol, the other phase of the process must proceed much more rapidly.

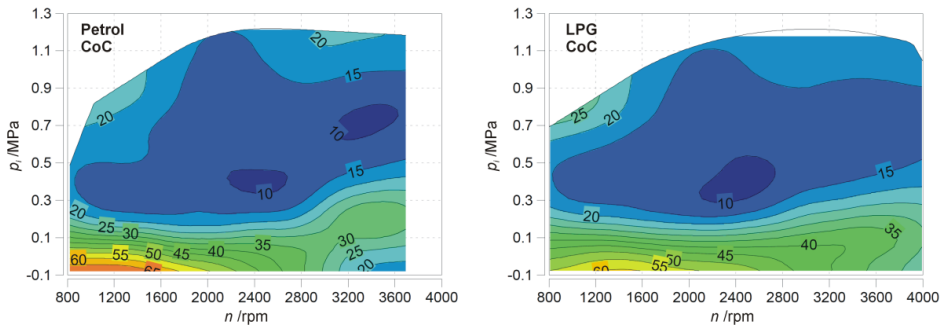

Fig. 18. Interpolated operating areas of engine fuelled with petrol and LPG during the acceleration phase, with indication of the centre of combustion (based on all recorded cycles during a test run)

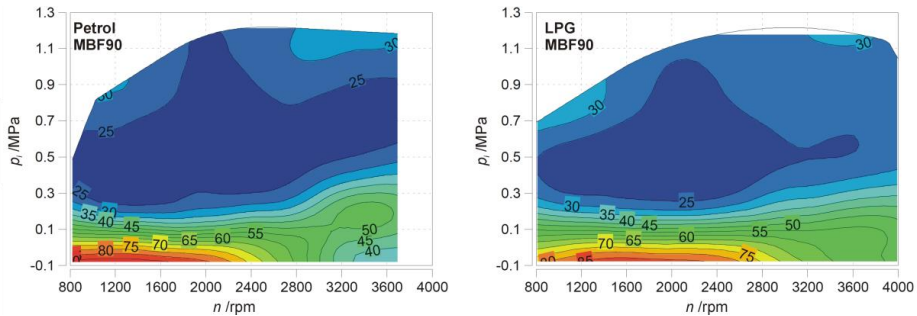

Fig. 19. Interpolated operating areas of engine fuelled with petrol and LPG during the acceleration phase, with indication of the 90% of mass burnt fuel (end of combustion; based on all recorded cycles during a test run)

- 5) During combustion of both fuels the tendency for increasing the maximum heat release rate  $dQ_{\max}$  with the increase of  $p_i$  can be noticed. During combustion of gaseous LPG fuel, however, a higher density of points for larger values of the mean indicated pressure and maximum heat release rate might be observed. This confirms that burning gaseous fuel progresses much faster and with greater intensity.
- 6) During petrol combustion a smaller value of the maximum heat release rate was obtained, with the offset of characteristics towards accelerated start of combustion compared to the characteristics of LPG combustion.

Analysis of the characteristics of the general operation of the engine fuelled with petrol and LPG makes it possible to determine the following dependencies:

- 1) During combustion of petrol the areas of the increased combustion rate appear, which is caused by the increase of the fuel dose at a given load. Increased combustion rates can indicate the possibility of obtaining greater acceleration of the vehicle with a petrol-fuelled engine compared to LPG-fuelled engine.
- 2) The petrol-fuelled engine achieves higher maximum values of combustion pressure already at about 2500 rpm, unlike LPG-fuelled engines, which achieve higher values after exceeding 2800 rpm.
- 3) Within the range of small loads, the CoC value is obtained faster than during combustion of LPG; it should be noted, however, that the maximum doses of LPG fuel burn longer at low engine speeds.

### Definitions/Abbreviations

<b>CNG</b>	Compressed Natural Gas
<b><math>dP/dn</math></b>	Indicated Mean Effective Pressure change per cycle
<b><math>dn</math></b>	Change of engine speed per one cycle
<b><math>(dP/d\alpha)_{\max}/dn</math></b>	Change of the combustion pressure increase rate per cycle
<b><math>dP_{\text{cyl}}/d\alpha</math></b>	maximum cylinder pressure rise rate
<b><math>dP_{\text{cyl-max}}/dn</math></b>	Change of the maximum combustion pressure per cycle
<b><math>dQ_{\max}</math></b>	Maximum rate of heat release
<b><math>dQ/d\alpha</math></b>	Rate of heat release
<b>LPG</b>	Liquefied Petroleum Gas
<b>MBF50, CoC</b>	Angle of 50% of heat release (centre of combustion)
<b>MBF90</b>	Angle of 90% of heat release (end of combustion)
<b><math>n</math></b>	Engine speed
<b><math>P_{\text{cyl}}</math></b>	Cylinder pressure
<b><math>P_{\text{cyl-max}}</math></b>	Maximum of cylinder pressure
<b><math>p_i</math></b>	Indicated Mean Effective Pressure
<b>SOC</b>	Start of combustion
<b><math>t_{\text{comb}}</math></b>	Angle of combustion duration
<b><math>Q</math></b>	Heat release
<b><math>Q_{\max}</math></b>	Maximum of heat release
<b><math>\alpha</math></b>	Crank angle

### References

- [1] ANDERSEN, P., 1999. *Algorithm for methane number determination for natural gasses*. Rep of Danish Gas Tech 16. ISBN:87-7795-125-5.
- [2] Autogas in Europe, 2014. *The Sustainable Alternative. An LPG Industry Roadmap*. 2013 Edition. European LPG Association. [www.aegpl.eu](http://www.aegpl.eu) (accessed 16.05.03).

- [3] BAYRAKTAR, H., DURGUN, O., 2004. Investigating the effects of LPG on spark ignition engine combustion and performance. *Energy Conversion and Management*, 46(13), pp. 2317-2333.
- [4] BOUNDY, B., DIEGEL, S.W., WRIGHT, L., DAVIS, S.C., 2011. *Biomass Energy Data Book*. Appendix A.
- [5] CIESLIK, M., BAJON, M., CZAJKA, J., BOROWSKI, P. et al., Performance indicators of engine powered by petrol and LPG in road conditions. *Scientific Conference LogiTrans 2014*, Poland, April 7-10.
- [6] ELNAJJAR, E., SELIM, M., HAMDAN, M., 2013. Experimental study of dual fuel engine performance using variable LPG composition and engine parameters. *Energy Conversion and Management*, 76, pp. 32-42.
- [7] European LPG association webpage. [www.aegpl.eu](http://www.aegpl.eu). (accessed 16.01.07).
- [8] FONTARAS, G., MANFREDI, U., MARTINI, G., DILARA, P. et al., 2012. *Experimental assessment of a Diesel-LPG dual fuel supply system for retrofit application in city busses*. SAE Technical Paper 2012-01-1944, doi:10.4271/2012-01-1944.
- [9] LAWANKAR, S., 2013. *Influence of compression ratio and ignition timing on the performance of LPG fuelled SI engine*. SAE Technical Paper 2013-01-2889, doi:10.4271/2013-01-2889.
- [10] LEE, D., ROH, H., BANG, S., LEE, C., 2013. *Spray characteristics of DME-LPG blended fuel in a high-pressure diesel injection system*. SAE Technical Paper 2013-01-0105, doi:10.4271/2013-01-0105.
- [11] MERKISZ, J., JACYNA, M., MERKISZ-GURANOWSKA, A., & PIELECHA, J., 2014. The parameters of passenger cars engine in terms of real drive emission test. *Archives of Transport*, 32(4), pp. 43-50.
- [12] MERKISZ-GURANOWSKA, A., & PIELECHA, J., 2014. Passenger cars and heavy duty vehicles exhaust emissions under real driving conditions. *Archives of Transport* 31(3), pp. 47-59.
- [13] MIZUSHIMA, N., SATO, S., OGAWA, Y., YAMAMOTO, T. et al., 2009. *Combustion characteristics and performance increase of an LPG-SI engine with liquid fuel injection system*. SAE Technical Paper 2009-01-2785, doi:10.4271/2009-01-2785.
- [14] PARK, C., PARK, Y., OH, S., LEE, Y. et al., 2013a. *Effect of injection timing retard on ISI strategy in lean-burning LPG direct injection engines*. SAE Technical Paper 2013-01-2636, doi:10.4271/2013-01-2636.
- [15] PARK, C., PARK, Y., OH, S., LEE, Y. et al., 2013b. *Emission characteristics of gasoline and LPG in a spray-guided-type direct injection engine*. SAE Technical Paper 2013-01-1323, doi:10.4271/2013-01-1323.
- [16] PIELECHA, I., BOROWSKI, P., 2014. *Investigations of the multiple fuel injection and atomization with the use of two outward-opening injectors*. SAE Technical Paper 2014-01-1402, doi:10.4271/2014-01-1402.
- [17] PIELECHA, I., BOROWSKI, P., CIESLIK, W., 2014. *Investigations into high-pressure diesel spray-wall interaction on reduction of exhaust emission from DI diesel engine*. SAE 2014-01-1250, doi:10.4271/2014-01-1250.
- [18] PIELECHA, I., BOROWSKI, P., CZAJKA, J., WISLOCKI, K., 2013. Spray analysis carried out with the use of two angularly arranged outward-opening injectors. *ILASS Americas 25th Annual Conference on Liquid Atomization and Spray Systems*, USA, May 5-8.
- [19] WISLOCKI, K., PIELECHA, I., CZAJKA, J., MASLENNIKOV, D., 2010a. Optical flame investigation in a combustion chamber fueled with CNG. *10th International conference on combustion and energy utilization – ICCEU 2010*, Turkey, May 4-8.
- [20] WISLOCKI, K., PIELECHA, I., CZAJKA, J., MASLENNIKOV, D., 2010b. Optical research on flame in a combustion chamber fuelled with CNG. *8th International Symposium on High Temperature Air Combustion and Gasification – HITACG*, Poland, July 5-7.